

Models

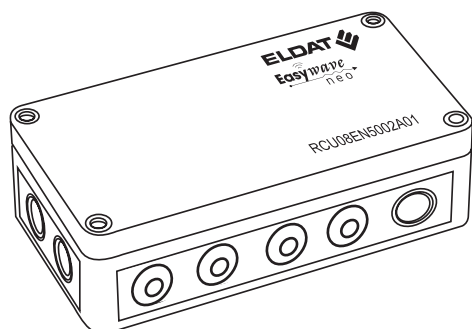

RCU08EN5002A01

Technical data

Frequency:	868.30 MHz
Modulation:	FSK
Coding:	Easywave neo
Power supply:	230 VAC 50 Hz
Output:	2 potential-free relay outputs 10 A 1x normally open contact 1x change-over contact
Input:	2 potential-free button inputs
Power consumption:	0.9W standby 2.3W max. without load
Contact load:	see load table
Degree of protection:	IP66 (in delivery condition)
Operating temperature:	-20 °C to +45 °C
Dimensions (W/L/H):	180/94/58 mm
Weight:	447 g

Scope of delivery

RCU08 receiver, operating manual

Load table

Load type	Max. load
Ohmic load: Incandescent lamps, 230 V Halogen lamps, etc.	10 A / 2,300 VA
Inductive load: Halogen lamps with wound transformers (transformer loaded at least 85%)	3 A / 690 VA
Non- or series-compensated fluorescent lamps with ferromagnetic ballasts	3 A / 690 VA
Parallel-compensated fluorescent lamps with ferromagnetic ballasts	3 A / 690 VA
ECG capacity: electronic ballasts, electronic transformers, etc.	4 A / 920 VA

Intended use

The device may only be used as a radio receiver for switching electrical loads according to the load table. Operation is carried out using Easywave radio transmitters, an Easywave neo transmitter, APC01 Easywave neo server or connected buttons / switches.

The manufacturer is not liable for damage caused by improper use or use contrary to the intended purpose.

Safety instructions

 Before operating the device, please read these instructions carefully! Failure to observe the instructions may result in fire or other hazards.

Attention! The device may only be operated on the 230V/50Hz AC mains. The electrical installation may only be carried out by an approved electrician (according to VDE 0100).



The device is part of a building installation. Observe applicable laws, standards and regulations of the country in which the devices are installed, as well as the instructions from the manufacturer for the devices to be switched!

Only load the device up to the specified power limit! The device must be fused with an upstream 10 A circuit breaker.

Have non-functioning devices checked by the manufacturer and do not make any unauthorised changes to the device!

Function

The RCU08 receiver is used for potential-free switching of mains or (protective) low voltage (SELV) for up to two consumers.

The receiver can be operated in ON/OFF, PULSE and DEAD MAN operating modes. The ON/OFF operating mode can also be used with two TIMER functions and one LOGIC function.

Up to two external buttons can be connected potential-free to the button inputs of the RCU08

Button inputs

In the factory state, the two external buttons EXT1 and EXT2 use the operating mode ON/OFF (☐) in 1-button operation. EXT1 is assigned to output 1 (CH1) and EXT2 is assigned to output 2 (CH2). This assignment is restored after an output or factory reset.

The factory assignment of the external buttons can be changed at any time. For this purpose, the buttons can be programmed or also deleted in any operating mode of the outputs CH1/CH2, analogue to radio transmitters.

As soon as a button is programmed to an output, the factory assignment is ignored. If, for example, the EXT1 button is programmed to output CH2, it will no longer switch output CH1. If the EXT1 button is to switch both outputs, it must be programmed to output CH2 as well as to its originally assigned output CH1.

External buttons behave like a transmitter button with the button code B and should always be programmed in 1-button operation.

The button inputs have priority over radio transmitters and can therefore be used, for example, to temporarily block an output. To do this, connect a switch and program it into the ON/OFF operating mode with 2-button operation (☐). As long as the switch is closed, the respective output also remains switched off.

If a switch is programmed in the DEAD MAN operating mode (☐), it switches the output ON as soon as it is closed. Radio transmitters can switch the output OFF again at any time.

Setting up the receiver

A Installing the receiver 1
 A1 Selecting the location..... 1
 A2 Mounting the receiver 1
 A3 Electrical connection..... 2
B Operation..... 2
 B1 Operating and indicator elements..... 2
 B2 Operating modes 3
 B3 Conversion table for timer..... 4
 B4 Timer multiplier table..... 4
C Programming 5
 C1 Programming transmitters/buttons..... 5
 C2 Adjust the timer..... 5
 C3 Deleting transmitters/buttons 6
 C4 Output reset 6
 C5 Factory reset..... 7
D Bidirectional functions 7
 D1 Programming a server 7
 D2 Deleting a server..... 7
E General information..... 8

A Installing the receiver

A1 Selecting the location

The device is considered to be an electrical switch according to EN 60669-2-1.

Note that installation in distribution boxes, enclosures made of metal, in the immediate vicinity of large metal objects, on the floor or near the floor can have a negative impact on the radio range. There are no restrictions with regard to the installation height.

A2 Mounting the receiver

1. Remove the housing cover.
2. Attach the receiver to the mounting location. Use the screw threads of the cover screws for this purpose.
3. Switch off the supply voltage.
4. Insert the connection cables through the double membrane glands. Pull the cable back briefly to form the seal.
5. Connect the cables for the power supply, consumers to be switched and, if necessary, external button according to the connection diagram (see section A3 "Electrical connection").

Mains power cables or cables connected to other circuits must not be used for the button connections!



6. Switch on the power supply (230 V AC).
7. Now program the transmitter codes for the transmitter and, if applicable, the external buttons on the receiver (see section C1 "Program transmitters/buttons").



The receiver is live during programming! Do not touch the terminals; there is a risk of electric shock!

8. Screw the housing cover back onto the lower part of the housing.

A Installing the receiver

A3 Electrical connection

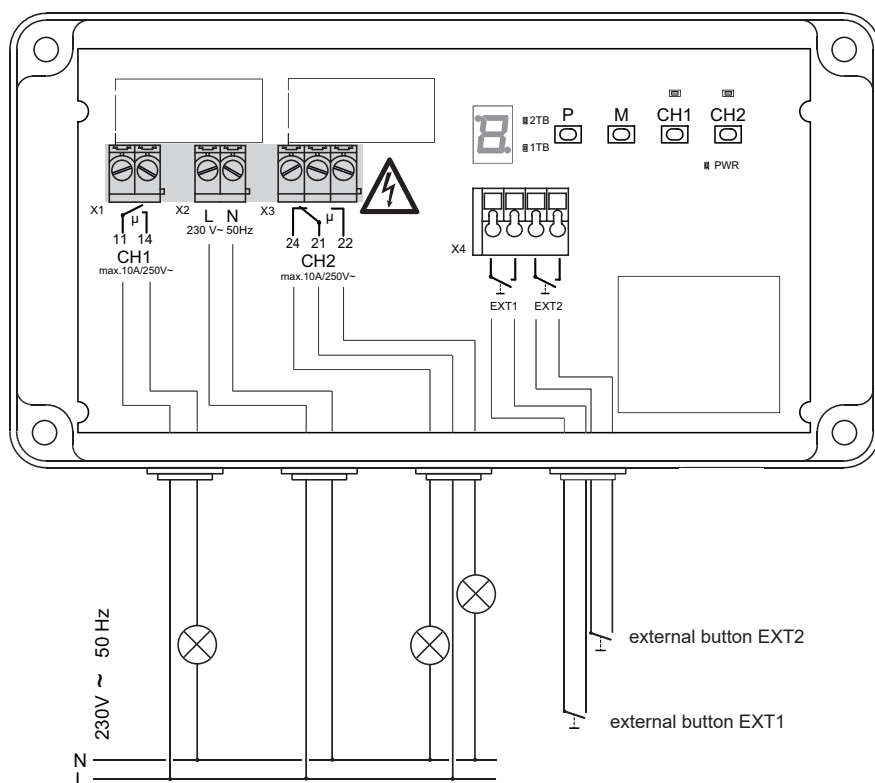

Cable cross-sections

Power supply and connection cables (X1-X3):

rigid cables: 0.5 - 2.5 mm²
 flexible cables
 with wire end ferrule: 0.5 - 1.5 mm²
 Up to two wires with max. 2.5 mm² can be connected per terminal X1, X2, X3.

external buttons (X4):

rigid cables: 0.2 - 1.5 mm²
 flexible cables
 with wire end ferrule: 0.2 - 0.75 mm²

B Operation

B1 Operating and indicator elements

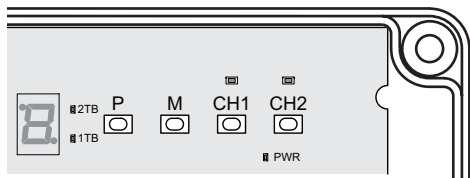

INDICATION	Operating mode	Programming mode
LED GREEN		
PWR Power	Supply voltage is applied, LED lights up.	
LED RED		
2TB 2-button operation	LED 2TB flashes when a wireless signal is detected.	Displays the selected mode. Signals the programming or delete mode.
1TB 1-button operation		
CH1 LED output 1 lights up	Relay 1 switched	Displays the output selected for programming.
CH2 LED output 2 lights up	Relay 2 switched	
Digital display	When a programmed transmission code is received, the corresponding operating mode is displayed for 2 s.	Display of the selected operating mode. Display of the seconds in TIMER programming.

OPERATION	Operating mode	Programming mode
P [P] Programming button	Start programming mode	Select operating mode
M [M] Mode button		Select operating mode
CH1 [CH1] Channel 1 button	Manually switch output 1 ON/OFF	Select output 1
CH2 [CH2] Channel 2 button	Manually switch output 2 ON/OFF	Select output 2



When switching to programming mode, all outputs are switched off and no switching operations are possible for the time of programming. When returned to operating mode, the outputs remain switched off.

B Operation

B2 Operating modes

By pressing the **P** button, you first determine whether you want to program a transmitter/button in **2-button operation** or in **1-button operation**.

Then select the desired operating mode by pressing the **M** button several times. The currently selected operating mode is shown in the digital display.

As soon as you have selected the output to be programmed, the desired transmission code/button can be programmed with the selected combination of operation and operating mode.

To do this, simply press the desired button of the transmitter or the button to be programmed.

In **2-button operation (2TB)**, the transmitter buttons **A** or **C** are for switching ON, starting the **TIMER** functions or retriggering them. The transmitter buttons **B** or **D** are for switching OFF or stopping the **TIMER** function. Only one transmitter button needs to be programmed into the receiver; the code for the second button is assigned automatically.

If a **PULSE** or **DEAD MAN** function is programmed in the 2TB, both buttons always carry out the same function! External buttons can only be used to a limited extent in 2-button operation.

In **1-button operation (1TB)**, each button can be used alternately for switching ON and OFF or for

triggering a **PULSE**.

Each button can be used to start and retrigger the timer and to carry out the dead man control.

Each button must be programmed into the receiver individually; there is no automatic assignment.

The logic function cannot be used with the 1TB. Therefore, the setting is ignored in this operating mode.

Operating modes

		2-button operation (2TB) Transmitter button				1-button operation (1TB) Transmitter button			
		A	B	C	D	A	B	C	D
ON/OFF	ON and OFF switching with the 1- or 2-button operation.								
I/O	If, when using the 1TB, the transmitter button or the button is pressed for longer than 1.6 s, all outputs in which the transmitter/button is programmed are switched off.	ON	OFF	ON	OFF	ON/ OFF	ON/ OFF	ON/ OFF	ON/ OFF
PULSE	If a transmitter button or a button is pressed, the relay switches for the duration of the time set in the operating mode. Only 1TB possible; with 2TB, both buttons trigger the same function								
1 s	Output is switched for 1.0 second	ON				OFF after timeout			
TIMER	The duration of the switching time is programmed permanently. The relay switches ON for the duration of the selected time. The switching time can be retriggered (retrig), i.e. if the button is pressed again before the time has elapsed, the switching time starts again from the beginning.								
3 min	Switches OFF after 3 minutes without shutdown warning.	ON/ retrig	OFF	ON/ retrig	OFF	ON/ retrig	ON/ retrig	ON/ retrig	ON/ retrig
7 min!	Switches OFF after 7 minutes with shutdown warning.*)	ON/ retrig	OFF	ON/ retrig	OFF	ON/ retrig	ON/ retrig	ON/ retrig	ON/ retrig
TIMER adjustable									
individual	The duration of the switching time can be set by the user. Each transmitter or button can be assigned its own switching time. The switching time assigned to a transmitter/button can only be changed by programming it in again. The factory setting is 15 minutes switching time without shutdown warning. The timer can be retriggered. Switching time min: 1s, max: 16:40h, shutdown warning optional.	ON/ retrig	OFF	ON/ retrig	OFF	ON/ retrig	ON/ retrig	ON/ retrig	ON/ retrig
global	The duration of the switching time can be set by the user. A separate switching time can be programmed for each channel. The programmed switching time applies to all transmitters/buttons for the respective channel that have been programmed in this operating mode. If the switching time is changed, the changes also affect transmitters/buttons that have already been programmed. The factory setting is 15 minutes switching time without shutdown warning. The timer can be retriggered. Switching time min: 1s, max: 16:40h, shutdown warning optional.	ON/ retrig	OFF	ON/ retrig	OFF	ON/ retrig	ON/ retrig	ON/ retrig	ON/ retrig
DEAD MAN	The output switches as long as the transmitter button or the button is pressed.								
max. 36 s	SWITCH OFF when the button is released or automatically after 36 seconds. External buttons or switches can switch the output ON without limitation, but do not have priority over radio transmitters in this operating mode.	ON		ON		ON	ON	ON	ON
LOGIC	Only possible for 2TB! All programmed transmission codes are linked according to an AND/OR logic. This operating mode is subordinate to all other operating modes! This means that any command from a transmitter programmed in another operating mode disables this operating mode! If another operating mode switches OFF while logic is ON, the logic function is reset. (But can be restarted at any time) External buttons cannot be used for this operating mode!								
Logic v / ^	OR link: If a transmitter that is programmed in this operating mode sends an A telegram (ON), the relay switches ON. AND link: If all the transmitters programmed in this operating mode, which previously sent an A telegram (ON), have sent a B telegram (OFF), the relay switches OFF.								

*) The switch-off process (!) is signalled as follows: 30 seconds before the end: Output switches 1x briefly OFF and ON again. 15 seconds before the end: Output switches 2x briefly OFF and ON again.

When using energy-saving lamps, a shutdown warning is not possible. Use of this function may cause damage to the lamp.

B Operation

B3 Conversion table for TIMER adjustable

Conversion seconds with multiplier in time (hours:minutes:seconds)

Seconds	Counter	Multiplier			
		1	10	100	1000
1	1	0:00:01	0:00:10	0:01:40	0:16:40
2	2	0:00:02	0:00:20	0:03:20	0:33:20
3	3	0:00:03	0:00:30	0:05:00	0:50:00
4	4	0:00:04	0:00:40	0:06:40	1:06:40
5	5	0:00:05	0:00:50	0:08:20	1:23:20
6	6	0:00:06	0:01:00	0:10:00	1:40:00
7	7	0:00:07	0:01:10	0:11:40	1:56:40
8	8	0:00:08	0:01:20	0:13:20	2:13:20
9	9	0:00:09	0:01:30	0:15:00	2:30:00
10	0	0:00:10	0:01:40	0:16:40	2:46:40
11	1	0:00:11	0:01:50	0:18:20	3:03:20
12	2	0:00:12	0:02:00	0:20:00	3:20:00
13	3	0:00:13	0:02:10	0:21:40	3:36:40
14	4	0:00:14	0:02:20	0:23:20	3:53:20
15	5	0:00:15	0:02:30	0:25:00	4:10:00
16	6	0:00:16	0:02:40	0:26:40	4:26:40
17	7	0:00:17	0:02:50	0:28:20	4:43:20
18	8	0:00:18	0:03:00	0:30:00	5:00:00
19	9	0:00:19	0:03:10	0:31:40	5:16:40
20	0	0:00:20	0:03:20	0:33:20	5:33:20
21	1	0:00:21	0:03:30	0:35:00	5:50:00
22	2	0:00:22	0:03:40	0:36:40	6:06:40
23	3	0:00:23	0:03:50	0:38:20	6:23:20
24	4	0:00:24	0:04:00	0:40:00	6:40:00
25	5	0:00:25	0:04:10	0:41:40	6:56:40
26	6	0:00:26	0:04:20	0:43:20	7:13:20
27	7	0:00:27	0:04:30	0:45:00	7:30:00
28	8	0:00:28	0:04:40	0:46:40	7:46:40
29	9	0:00:29	0:04:50	0:48:20	8:03:20
30	0	0:00:30	0:05:00	0:50:00	8:20:00

Seconds	Counter	Multiplier			
		1	10	100	1000
31	1	0:00:31	0:05:10	0:51:40	8:36:40
32	2	0:00:32	0:05:20	0:53:20	8:53:20
33	3	0:00:33	0:05:30	0:55:00	9:10:00
34	4	0:00:34	0:05:40	0:56:40	9:26:40
35	5	0:00:35	0:05:50	0:58:20	9:43:20
36	6	0:00:36	0:06:00	1:00:00	10:00:00
37	7	0:00:37	0:06:10	1:01:40	10:16:40
38	8	0:00:38	0:06:20	1:03:20	10:33:20
39	9	0:00:39	0:06:30	1:05:00	10:50:00
40	0	0:00:40	0:06:40	1:06:40	11:06:40
41	1	0:00:41	0:06:50	1:08:20	11:23:20
42	2	0:00:42	0:07:00	1:10:00	11:40:00
43	3	0:00:43	0:07:10	1:11:40	11:56:40
44	4	0:00:44	0:07:20	1:13:20	12:13:20
45	5	0:00:45	0:07:30	1:15:00	12:30:00
46	6	0:00:46	0:07:40	1:16:40	12:46:40
47	7	0:00:47	0:07:50	1:18:20	13:03:20
48	8	0:00:48	0:08:00	1:20:00	13:20:00
49	9	0:00:49	0:08:10	1:21:40	13:36:40
50	0	0:00:50	0:08:20	1:23:20	13:53:20
51	1	0:00:51	0:08:30	1:25:00	14:10:00
52	2	0:00:52	0:08:40	1:26:40	14:26:40
53	3	0:00:53	0:08:50	1:28:20	14:43:20
54	4	0:00:54	0:09:00	1:30:00	15:00:00
55	5	0:00:55	0:09:10	1:31:40	15:16:40
56	6	0:00:56	0:09:20	1:33:20	15:33:20
57	7	0:00:57	0:09:30	1:35:00	15:50:00
58	8	0:00:58	0:09:40	1:36:40	16:06:40
59	9	0:00:59	0:09:50	1:38:20	16:23:20
60	0	0:01:00	0:10:00	1:40:00	16:40:00

B4 Timer multiplier table

Multiplier	
A	1 x seconds
C	10 x seconds
E	100 x seconds
F	1000 x seconds
H	100 x seconds with shutdown warning

Please note that the times given here are approximate. Due to the calculation method and component tolerances, deviations may occur. The longer the set time, the greater the deviation.

C Programming

C1 Programming transmitters/buttons

If a previously programmed transmitter/button is programmed again in the same output, the previous operating mode is overwritten with the new operating mode.

32 transmission codes can be programmed per output.

External buttons are programmed just like radio transmitters and should be used in 1-button operation (1TB).

If the external buttons have not been programmed in another operating mode, they operate in the ON/OFF operating mode (4) with 1-button operation.

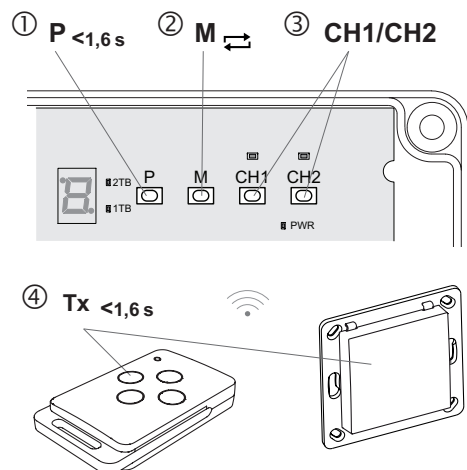

	Operation 1) [Press button]	Indication	Note
Programming 2TB	① P 1x briefly	LED 2TB flashes	Programming mode 2-button operation started.
	② M repeatedly	Number for the OM in the digital display	Select operating mode (OM).
	③ CH1/CH2	LED CH1/CH2 and LED 2TB flash	Select output. Only one output can be active at a time; change as often as required.
	④ Transmitter button Tx or button 1x briefly	LED 2TB and LED of the selected output light up	Transmission code/button code programmed. When all the LEDs turn off, the receiver is ready for operation.
Programming 1TB	① P 2x briefly	LED 1TB flashes	Programming mode 1-button operation started.
	② M repeatedly	Number for the OM in the digital display	Select operating mode (OM).
	③ CH1/CH2	LED CH1/CH2 and LED 1TB flash	Select output. Only one output can be active at a time; change as often as required.
	④ Transmitter button Tx or button 1x briefly	LED 1TB and LED of the selected output light up	Transmitter/button programmed. When all the LEDs turn off, the receiver is ready for operation.

1) Timeout: If no buttons are pressed within 30 seconds, the RCU08 automatically switches back to operating mode. The settings are not saved.

Programming can be cancelled by pressing the P button several times. The order is: 2TB → 1TB → Operating mode. In operating mode, all red LEDs and the display are off, as long as no output is activated.

C2 Adjust TIMER

The switching times for operating modes 4 and 5 can be set individually for each output.

The switching time is calculated using the base time measured during programming and the selected multiplier.

The maximum base time is 60 seconds. After this time, the measurement stops automatically and skips to the multiplier selection.

TIMER individual (4)

The set switching time applies individually to every transmitter/button programmed to this operating mode.

The most recently set switching time is saved and used during programming.

The switching time assigned to a transmitter/button can only be changed by programming the transmitter/button again.

TIMER global (5)

The set switching time applies globally to all transmitters/buttons programmed to an output.

The most recently set switching time set is also used for transmitters/buttons that have already been programmed.

	Operation [Press button]	Indication	Note
	1. P 1x briefly	LED 2TB flashes	Programming mode started
	2. M repeatedly	Number of the OM in the display	Select the timer mode to be adjust. (4 or 5)
	3. CH1/CH2	LED CH1/CH2 and LED 2TB flash	Select output. Only one output can be selected.
	4. P > 1.6 s	LED 2TB + 1TB flash alternately Display: Seconds count up	The measurement of the base time for the timer is started. In the display, the seconds count up from 1-10 (0) a maximum of 6 times. After a maximum of 60 s, the measurement is stopped automatically.
	5. P 1x briefly	2TB+1TB light up Display: Multiplier (A) flashes	The measurement of the base time is stopped. The currently selected multiplier is shown in the display.
	6. M repeatedly	2TB + 1TB light up Display: current multiplier flashes	Set the multiplier to be used for the time just measured (see section B4, "Timer multiplier table").
	7. P 1x briefly	2TB+1TB light up Display: multiplier selected lights up	The measured time is multiplied by the selected multiplier and saved as the new switching time. When all the LEDs turn off, the receiver is ready for operation.

C Programming

C3 Deleting transmitters/buttons

In delete mode, individual transmitters/buttons can be deleted from the memory of an output.

External buttons can be "deleted" in the same way.

If an external button is "deleted" from all outputs, it works again in the ON/OFF operating mode () 1-button operation in the factory-set output.

Complete deactivation of the button inputs is not possible.

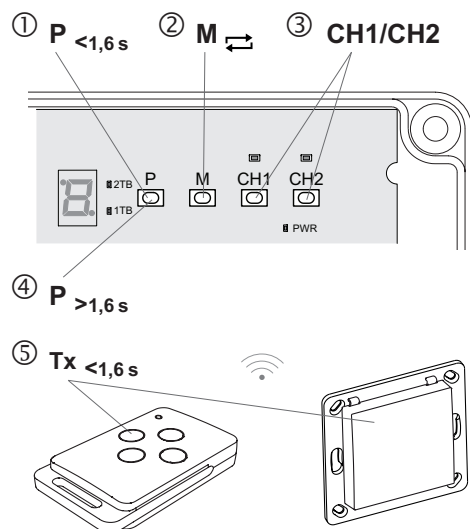

Operation 1) [Press button]	Indication	Note
① P 1x briefly or P 2x briefly	LED 2TB flashes LED 1TB flashes	Programming mode started.
② M repeatedly		Select delete function L.
③ CH1/CH2	LED CH1/CH2 and LED xTB flash	Select output. Only one output can be selected. Output can be changed as often as required.
④ P > 1.6 s	LED output + 2TB + 1TB flash quickly	Delete mode started. Cancel 1x P < 1.6 s
⑤ Transmitter button Tx or button 1x briefly	LED output + 2TB + 1TB light up	Transmitter/button deleted from the selected output. When all the LEDs turn off, the receiver is ready for operation.

1) If no buttons are pressed within 30 seconds, the RCU08 automatically switches back to operating mode. The settings are not saved.

 If a transmitter/button is programmed in several outputs, it may have to be deleted from each output individually.
If an attempt is made to delete a transmitter/button that is not programmed in the selected output, the LEDs flash quickly and the receiver remains in delete mode.

C4 Output reset

A separate reset can be performed for each output.

All programmed transmitters/buttons are deleted and all switching times for the respective output are reset.

The external button input belonging to the output is assigned to the relevant output again:

Output 1 (CH1): EXT1 button → 1TB, ON/OFF

Output 2 (CH2): EXT2 button → 1TB, ON/OFF

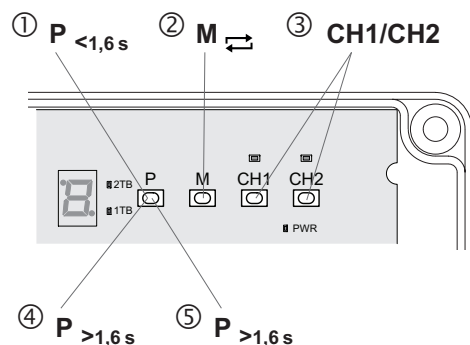

Operation 1) [Press button]	Indication	Note
① P 1x briefly or P 2x briefly	LED 2TB flashes LED 1TB flashes	Programming mode started.
② M repeatedly		Select delete function L.
③ CH1/CH2	LED CH1/CH2 and LED xTB flash	Select output. Only one output can be selected. Output can be changed as often as required.
④ P > 1.6 s	LED output + 2TB + 1TB flash quickly	Delete mode started Cancel 1x P < 1.6 s
⑤ P > 1.6 s	LED output + 2TB + 1TB light up	All transmitters/buttons from the selected output deleted and TIMER reset. When all the LEDs turn off, the receiver is ready for operation.

1) If no buttons are pressed within 30 seconds, the RCU08 automatically switches back to operating mode. The settings are not saved.

C Programming

C5 Factory reset

Performing a factory reset restores all settings of **all** outputs to the factory default.

All programmed transmitters and, if applicable, also the server are deleted and all switching times set back to the default value.

The external button inputs are assigned to the original output again:

EXT1 button: Output 1 (CH1) -> 1TB, ON/OFF

EXT2 button: Output 2 (CH2) -> 1TB, ON/OFF

Operation [Press button]	Indication	Note
1. M keep pressed		
2. CH1 + CH2 keep pressed for 5 s	Symbol  is displayed for 4 s.	Factory reset has been carried out, all settings have been reset. When the display is off, the receiver is ready for operation.

D Bidirectional functions (Easywave neo)

To enable the use of bidirectional functionalities, an APC01 Easywave neo server can be programmed to the RCU08.

The RCU08 is automatically recognised and configured by the server as a 2-fold switch receiver.

During programming, the server automatically recognises the number of available channels and does not have to be separately programmed into each channel.

The available range of functions is also recognised automatically, so that no specific operating mode has to be selected when programming in a server.

Program the APC01 server according to the instructions in the Easywave app.



After programming, the server receives feedback of every switching operation carried out, even if the operation is triggered by another transmitter/button or manually by the CH1 and CH2 buttons on the RCU08.

This means that the current status of each output can be shown via the relevant app at any time.

An incoming switch command via the server is shown as a dash (-) on the display of the RCU08.

D1 Programming a server

Only one server at a time can be programmed into the receiver. A server that has already been programmed will be overwritten.

Operation [Press button]	Indication	Note
1. Start the programming process in the app. As soon as you are prompted in the app, start the programming mode on the receiver (see point 2.).		
2. P press 1x briefly	The display shows the last operating mode selected.	All operating modes possible except  (delete mode). If the display shows  , press the M button 1x briefly to exit the delete mode.
3. Complete the programming process via the app.		

D2 Deleting a server

To delete a server, the receiver must be supplied with power.

Alternatively, for deletion via the app, the server can also be deleted by performing a factory reset on the receiver.

Operation [Press button]	Indication	Note
1. Delete the receiver in the app while the receiver is supplied with power and is within range of the server.		

E General information

Disposal

Old devices must not be disposed of with household waste!

Dispose of the waste product at a designated collection point for electronic waste or via your specialist retailer.



Dispose of the packaging material in the recycling containers for cardboard, paper and plastics.



Warranty

During the warranty period, we undertake to rectify free of charge by repair or replacement any product defects arising from production or material faults.

Any unauthorised tampering with, or modifications to, the product shall render this warranty null and void.

Conformity



ELDAT EaS GmbH hereby declares that the radio equipment type RCU08 is in compliance with the Directive 2014/53/EU.

The full text of the EU declaration of conformity can be obtained at the following internet address: www.eldat.de

Customer service

If, despite correct handling, faults or malfunctions occur or in case of damage, please contact your retailer or the manufacturer.

ELDAT EaS GmbH

Schmiedestraße 2

15475 Wildau

Germany

Phone: + 49 33 75 / 90 37-310

Fax: + 49 33 75 / 90 37-90

Internet: www.eldat.de

E-mail: info@eldat.de